

MARTES 27 DE ABRIL

CIENCIAS SOCIALES

TAREA CON NOTA PARA ENTREGAR POR MAIL

[\(jessi.leiva.4a@gmail.com\)](mailto:jessi.leiva.4a@gmail.com)

CONTINUAMOS CON PLANOS

6- Dibuja el plano de tu casa y colócale referencias.

(Te dejo como ejemplo el plano de mi casa)

FRENTE

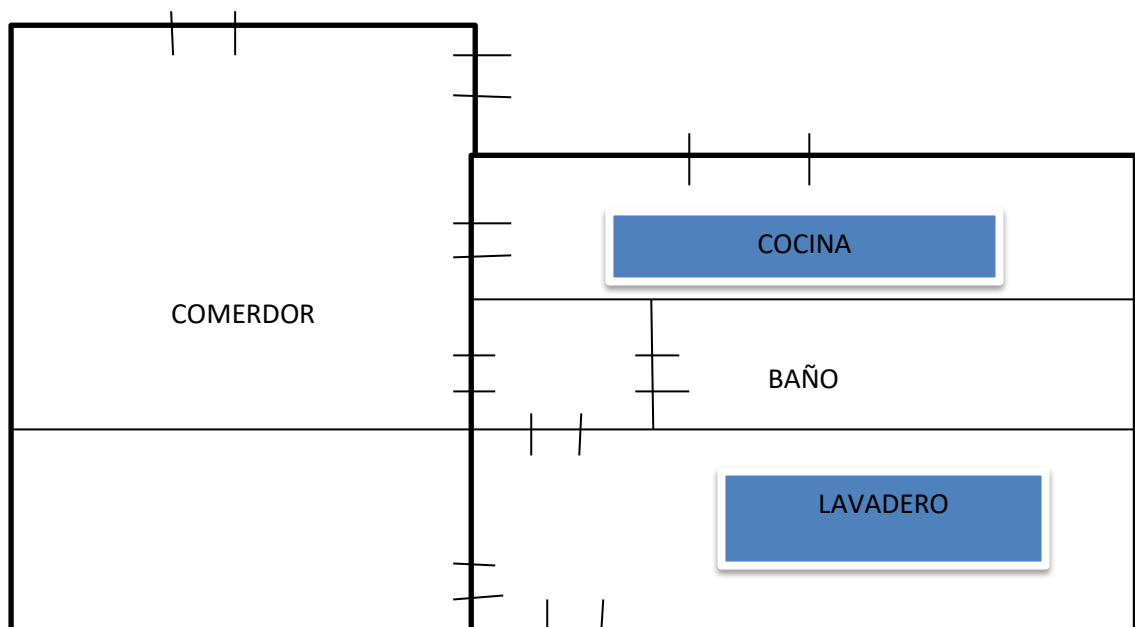











Referencias

 PUERTAS Y VENTANAS

7- Dibuja el plano de tu barrio con las manzanas que sean necesarias para marcar puntos o lugares de referencia importantes. Puedes agregar los nombres de las calles.

(te dejo este plano como ejemplo)

REFERENCIAS

-  CAMPO
-  MI CASA
-  VIAS DEL TREN
-  TANQUE DE AGUA
-  PLAZA
-  FABRICA ABANDONADA

